



## SHENZHEN COBAN ELECTRONICS CO., LIMITED

---

# CE EMC REPORT

Prepared For :	SHENZHEN COBAN ELECTRONICS CO., LIMITED  6/F, Bldg. 8, Zhiheng Industrial Park, Guankou 2nd Road, Nantou, nanshan, Shenzhen,China
Product Name:	GPS TRACKER
Trade Name:	Coban
Model :	GPS103, GPS103A, GPS103B, GPS103C, GPS103D, GPS103E, GPS103F, GPS103G, GPS103H
Prepared By :	Shenzhen BST Technology Co., Ltd.  Building No.23-24, Zhiheng Industrial Park, Guankouer Road, Nantou,Nanshan District,Shenzhen,Guangdong,China
Test Date:	Jan. 02-03, 2014
Date of Report :	Jan. 04, 2014
Report No.:	BST13120817Y-1ER-1



## TABLE OF CONTENTS

<b>TEST REPORT DECLARATION</b> .....	<b>5</b>
<b>1. TEST RESULTS SUMMARY</b> .....	<b>6</b>
<b>2. GENERAL INFORMATION</b> .....	<b>7</b>
2.1. Report information .....	7
2.2. Measurement Uncertainty .....	7
<b>3. PRODUCT DESCRIPTION</b> .....	<b>8</b>
3.1. EUT Description.....	8
3.2. Block Diagram of EUT Configuration .....	8
3.3. Operating Condition of EUT .....	8
3.4. Test Conditions.....	8
3.5. Modifications.....	8
3.6. Abbreviations .....	9
3.7. Performance Criterion .....	9
<b>4. TEST EQUIPMENT USED</b> .....	<b>10</b>
4.1. For Conducted Emission Test .....	10
4.2. For Radiated Emission Measurement.....	10
4.3. For Harmonic / Flicker Test .....	10
4.4. For Electrostatic Discharge Immunity Test.....	10
4.5. For RF Strength Susceptibility Test .....	10
4.6. For Electrical Fast Transient/Burst Immunity Test .....	11
4.7. For Surge Test .....	11
4.8. For Injected Currents Susceptibility Test .....	11
4.9. For Magnetic Field Immunity Test.....	11
4.10. For Voltage Dips and Interruptions Test.....	11
<b>5. POWER LINE CONDUCTED EMISSION TEST</b> .....	<b>12</b>
5.1. Block Diagram of Test Setup .....	12
5.2. Test Standard.....	12
5.3. Power Line Conducted Emission Limit .....	12
5.4. EUT Configuration on Test.....	12
5.5. Operating Condition of EUT .....	13
5.6. Test Procedure .....	13
5.7. Test Result.....	13
<b>6. RADIATED EMISSION TEST</b> .....	<b>14</b>
6.1. Setup Diagram.....	14
6.2. Test Standard.....	14
6.3. Radiated Emission Limit .....	14
6.4. EUT Configuration on Test.....	15
6.5. Operating Condition of EUT .....	15
6.6. Test Procedure .....	15
6.7. Test Results .....	15



<b>7. HARMONIC CURRENT EMISSION TEST .....</b>	<b>16</b>
7.1. Block Diagram of Test Setup .....	16
7.2. Test Standard and Limit .....	16
7.3. Test Procedure .....	17
7.4. Test Results .....	17
<b>8. VOLTAGE FLUCTUATIONS &amp; FLICKER TEST .....</b>	<b>18</b>
8.1. Block Diagram of Test Setup .....	18
8.2. Test Standard .....	18
8.3. Operating Condition of EUT .....	18
8.4. Test Results .....	18
<b>9. ELECTROSTATIC DISCHARGE TEST .....</b>	<b>19</b>
9.1. Block Diagram of ESD Test Setup .....	19
9.2. Test Standard .....	19
9.3. Severity Levels and Performance Criterion .....	19
9.4. EUT Configuration on Test .....	19
9.5. Operating Condition of EUT .....	19
9.6. Test Procedure .....	20
9.7. Test Results .....	20
<b>10. RF FIELD STRENGTH SUSCEPTIBILITY TEST .....</b>	<b>22</b>
10.1. R/S Test Setup .....	22
10.2. Test Standard .....	22
10.3. Severity Levels and Performance Criterion .....	22
10.4. EUT Configuration on Test .....	23
10.5. Operating Condition of EUT .....	23
10.6. Test Procedure .....	23
10.7. Test Results .....	23
<b>11. ELECTRICAL FAST TRANSIENT/BURST TEST .....</b>	<b>25</b>
11.1. EFT Test Setup .....	25
11.2. Test Standard .....	25
11.3. Severity Levels and Performance Criterion .....	25
11.4. EUT Configuration on Test .....	25
11.5. Operating Condition of EUT .....	25
11.6. Test Procedure .....	26
11.7. Test Results .....	26
<b>12. SURGE TEST .....</b>	<b>28</b>
12.1. Surge Test Setup .....	28
12.2. Test Standard .....	28
12.3. Severity Levels and Performance Criterion .....	28
12.4. EUT Configuration on Test .....	28
12.5. Operating Condition of EUT .....	28
12.6. Test Procedure .....	29
12.7. Test Results .....	29
<b>13. INJECTED CURRENTS SUSCEPTIBILITY TEST .....</b>	<b>31</b>
13.1. Block Diagram of Test AC Mains Setup .....	31
13.2. Test Standard .....	31
13.3. Severity Levels and Performance Criterion .....	31
13.4. EUT Configuration on Test .....	31



13.5. Operating Condition of EUT .....	31
13.6. Test Procedure .....	32
13.7. Test Results .....	32
<b>14. MAGNETIC FIELD IMMUNITY TEST .....</b>	<b>34</b>
14.1. Block Diagram of Test Setup .....	34
14.2. Test Standard .....	34
14.3. Severity Levels and Performance Criterion.....	34
14.4. EUT Configuration on Test.....	34
14.5. Operating Condition of EUT .....	35
14.6. Test Procedure .....	35
14.7. Test Results .....	35
<b>15. VOLTAGE DIPS AND INTERRUPTIONS TEST .....</b>	<b>37</b>
15.1. Voltage Dips and Interruptions Test Setup .....	37
15.2. Test Standard.....	37
15.3. Severity Levels and Performance Criterion.....	37
15.4. EUT Configuration on Test.....	37
15.5. Operating Condition of EUT .....	37
15.6. Test Procedure .....	38
15.7. Test Result.....	38
<b>APPENDIX I .....</b>	<b>40</b>
<b>APPENDIX II.....</b>	<b>43</b>



## TEST REPORT DECLARATION

Applicant	:	SHENZHEN COBAN ELECTRONICS CO., LIMITED
Address	:	6/F, Bldg. 8, Zhiheng Industrial Park, Guankou 2nd Road, Nantou, nanshan, Shenzhen, China
EUT Description	:	GPS TRACKER
Model Number	:	GPS103, GPS103A, GPS103B, GPS103C, GPS103D, GPS103E, GPS103F, GPS103G, GPS103H <b>(Note: The series products have the same circuit diagram, PCB layout and functionality. The differences are the model name and appearance, so, we select GPS103 to test.)</b>

Test Standards:

EN 55022:2010  
EN 61000-3-2:2006+A1:2009+A2:2009  
EN61000-3-3:2008  
EN 55024:2010

The EUT described above is tested by BST Technology Co., Ltd. EMC Laboratory to determine the maximum emissions from the EUT and ensure the EUT to be compliance with the immunity requirements of the EUT. BST Technology Co., Ltd. EMC Laboratory is assumed full responsibility for the accuracy of the test results. Also, this report shows that the EUT technically complies with the 2004/108/EC directive and its amendment requirements.

The test report is valid for above tested sample only and shall not be reproduced in part without written approval of the laboratory.

Prepared by :

Jane lei

Assistant

Tested by :

Aidan.zhu

Test Engineer

Reviewer :

gby zhang

Supervisor

Approved & Authorized Signer :

Christina

Christina / Manager



## 1. TEST RESULTS SUMMARY

Table 1 Test Results Summary

Test Items	Test Results
Radiated Emission	PASS
Conducted Disturbance	N/A
Harmonic Current	N/A
Voltage Fluctuation and Flicker	N/A
Electrostatic Discharge Immunity	PASS
Radiated Electromagnetic Fields Immunity	PASS
Electric Fast Transient Burst Immunity	N/A
Surge Immunity	N/A
Injected currents susceptibility test	N/A
Magnetic Field Immunity Test	PASS
Voltage dips and interruptions Immunity	N/A



## 2. GENERAL INFORMATION

### 2.1. Report information

- 2.1.1. This report is not a certificate of quality; it only applies to the sample of the specific product/equipment given at the time of its testing. The results are not used to indicate or imply that they are application to the similar items. In addition, such results must not be used to indicate or imply that BST approves recommends or endorses the manufacture, supplier or use of such product/equipment, or that BST in any way guarantees the later performance of the product/equipment.
- 2.1.2. The sample/s mentioned in this report is/are supplied by Applicant, BST therefore assumes no responsibility for the accuracy of information on the brand name, model number, origin of manufacture or any information supplied.
- 2.1.3. Additional copies of the report are available to the Applicant at an additional fee. No third part can obtain a copy of this report through BST, unless the applicant has authorized BST in writing to do so.

### 2.2. Measurement Uncertainty

Available upon request.



### 3. PRODUCT DESCRIPTION

#### 3.1. EUT Description

Description	:	GPS TRACKER
Applicant	:	SHENZHEN COBAN ELECTRONICS CO., LIMITED 6/F, Bldg. 8, Zhiheng Industrial Park, Guankou 2nd Road, Nantou, nanshan, Shenzhen,China
Manufacturer	:	SHENZHEN COBAN ELECTRONICS CO., LIMITED 6/F, Bldg. 8, Zhiheng Industrial Park, Guankou 2nd Road, Nantou, nanshan, Shenzhen,China
Model Number	:	GPS103, GPS103A, GPS103B, GPS103C, GPS103D, GPS103E, GPS103F, GPS103G, GPS103H

#### 3.2. Block Diagram of EUT Configuration

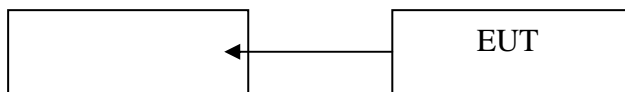

#### 3.3. Operating Condition of EUT

Test mode 1: ON

#### 3.4. Test Conditions

Temperature: 23-26°C

Relative Humidity: 55-68 %

#### 3.5. Modifications

No modification was made.





### 3.6. Abbreviations

AC	Alternating Current
AMN	Artificial Mains Network
DC	Direct Current
EM	ElectroMagnetic
EMC	ElectroMagnetic Compatibility
EUT	Equipment Under Test
IF	Intermediate Frequency
RF	Radio Frequency
rms	root mean square
EMI	Electromagnetic Interference
EMS	Electromagnetic Susceptibility

### 3.7. Performance Criterion

**Criterion A:** The equipment shall continue to operate as intended without operator intervention. No degradation of performance or loss of function is allowed below a performance level specified by the manufacturer when the equipment is used as intended.

**Criterion B:** After the test, the equipment shall continue to operate as intended without operator intervention. No degradation of performance or loss of function is allowed, after the application of the phenomena below a performance level specified by the manufacturer, when the equipment is used as intended.

**Criterion C:** Loss of function is allowed, provided the function is self-recoverable, or can be restored by the operation of the controls by the user in accordance with the manufacturer's instructions.



## 4. TEST EQUIPMENT USED

### 4.1. For Conducted Emission Test

Item	Equipment	Manufacturer	Model No.	Serial No.	Last Cal.	Cal. Interval
1.	Test Receiver	Rohde & Schwarz	ESHS30	828985/018	Jun. 01, 13	1 Year
2.	Pulse Limiter	Rohde & Schwarz	ESH3-Z2	100006	Jun. 01, 13	1 Year
3.	L.I.S.N.	Rohde & Schwarz	ESH2-Z5	834549/005	Jun. 01, 13	1 Year
4.	Conical	Emtek	N/A	N/A	N/A	N/A
5.	Voltage Probe	Schwarzbeck	TK9416	N/A	Jun. 01.13	1 Year
6.	Coaxial Switch	Anritsu	MP59B	6100214550	Jun. 01, 13	1 Year

### 4.2. For Radiated Emission Measurement

Item	Equipment	Manufacturer	Model No.	Serial No.	Last Cal.	Cal. Interval
1.	Spectrum Analyzer	ANRITSU	MS2661C	6200140915	Jun 01,13	1 Year
2.	Test Receiver	Rohde&Schwarz	ESC830	828982/018	Jun 01,13	1 Year
3.	Bilog Antenna	Schwarzbeck	VULB9163	142	Jun 01,13	1 Year
4.	50 Coaxial Switch	Anritsu Corp	MP59B	6100237248	Jun 01,13	1 Year
5.	Cable	Schwarzbeck	AK9513	ACRX1	Jun 01,13	1 Year
6.	Cable	Rosenberger	N/A	FR2RX2	Jun 01,13	1 Year
7.	Cable	Schwarzbeck	AK9513	CRRX2	Jun 01,13	1 Year
8.	Cable	Schwarzbeck	AK9513	CRRX2	Jun 01,13	1 Year
9.	Signal Generator	HP	864A	3625U00573	Jun 01,13	1 Year

### 4.3. For Harmonic / Flicker Test

Item	Equipment	Manufacturer	Model No.	Serial No.	Last Cal.	Cal. Interval
1.	Harmonic and Flicker analyzer	Laplace	AC2000A	309709	Oct. 15, 2013	1 Year

### 4.4. For Electrostatic Discharge Immunity Test

Item	Equipment	Manufacturer	Model No.	Serial No.	Last Cal.	Cal. Interval
1.	ESD Tester	HAEFELY	PSD 1600	H911'292	Jun. 02, 13	1 Year

### 4.5. For RF Strength Susceptibility Test

Item	Equipment	Manufacturer	Model No.	Serial No.	Last Cal.	Cal. Interval
1.	Signal Generator	HP	8648A	3633A02081	Jun. 03, 13	1 Year
2.	Amplifier	A&R	500A100	17034	NCR	NCR
3.	Amplifier	A&R	100W/1000M1	17028	NCR	NCR
4.	Isotropic Field Monitor	A&R	FM2000	16829	NCR	NCR
5.	Isotropic Field Probe	A&R	FLW220100	16755	Jun. 03, 13	1 Year
6.	Biconic Antenna	EMCO	3108	9507-2534	NCR	NCR
7.	Log-periodic Antenna	A&R	AT1080	16812	NCR	NCR
8.	PC	N/A	486DX2	N/A	N/A	N/A



#### 4.6. For Electrical Fast Transient/Burst Immunity Test

Item	Equipment	Manufacturer	Model No.	Serial No.	Last Cal.	Cal. Interval
1.	Burst Tester	HAEFELY	PEFT 4010	080981-16	Jun. 01, 13	1 Year

#### 4.7. For Surge Test

Item	Equipment	Manufacturer	Model No.	Serial No.	Last Cal.	Cal. Interval
1.	Surge Tester	HAEFELY	PSURGE4.1	080107-04	Jun. 01, 13	1 Year

#### 4.8. For Injected Currents Susceptibility Test

Item	Equipment	Manufacturer	Model No.	Serial No.	Last Cal.	Cal. Interval
1.	Simulator	EMTEST	CWS 500C	0900-12	Jun. 01, 13	1 Year
2.	CDN	EMTEST	CDN-M2	510010010010	Jun. 01, 13	1 Year
3.	VDN	EMTEST	CDN-M3	0900-11	Jun. 01, 13	1 Year
4.	Injection Clamp	EMTEST	F-2031-23MM	368	Jun. 01, 13	1 Year
5.	Attenuator	EMTEST	ATT6	0010222a	Jun. 01, 13	1 Year

#### 4.9. For Magnetic Field Immunity Test

Item	Equipment	Manufacturer	Model No.	Serial No.	Last Cal.	Cal. Interval
1.	Magnetic Field Tester	HAEFELY	MAG100.1	083858-10	Jun. 01, 13	1 Year

#### 4.10. For Voltage Dips and Interruptions Test

Item	Equipment	Manufacturer	Model No.	Serial No.	Last Cal.	Cal. Interval
2.	Dips Tester	HAEFELY	PLINE 1610	083732-18	Jun. 01, 13	1 Year



## 5. POWER LINE CONDUCTED EMISSION TEST

### 5.1. Block Diagram of Test Setup

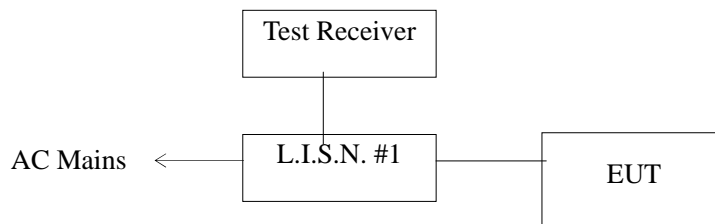

### 5.2. Test Standard

EN 55022:2010

### 5.3. Power Line Conducted Emission Limit

Frequency MHz	Limits dB( $\mu$ V)	
	Quasi-peak Level	Average Level
0.15 ~ 0.50	66 ~ 56*	56 ~ 46*
0.50 ~ 5.00	56	46
5.00 ~ 30.00	60	50

Notes: 1. \*Decreasing linearly with logarithm of frequency.

2. The lower limit shall apply at the transition frequencies.

### 5.4. EUT Configuration on Test

The following equipments are installed on conducted emission test to meet EN55022 requirement and operating in a manner, which tends to maximize its emission characteristics in a normal application.

#### 5.4.1. EUT Information

Model Number : GPS103  
Serial Number : N/A  
Manufacturer : SHENZHEN COBAN ELECTRONICS CO., LIMITED



## 5.5. Operating Condition of EUT

5.5.1. Setup the EUT and simulators as shown in Section 5.1.

5.5.2. Turn on the power of all equipments.

5.5.3. Let the EUT work in test modes (ON) and test it.

## 5.6. Test Procedure

The EUT is put on the ground and connected to the AC mains through a Artificial Mains Network (AMN). This provided 50ohm-coupling impedance for the tested equipments. Both sides of AC line are checked to find out the maximum conducted emission levels according to the EN55022 regulations during conducted emission test.

The bandwidth of the test receiver (R&S Test Receiver ESHS30) is set at 10KHz.

The frequency range from 150 KHz to 30 MHz is investigated.

## 5.7. Test Result

N/A



## 6. RADIATED EMISSION TEST

### 6.1. Setup Diagram

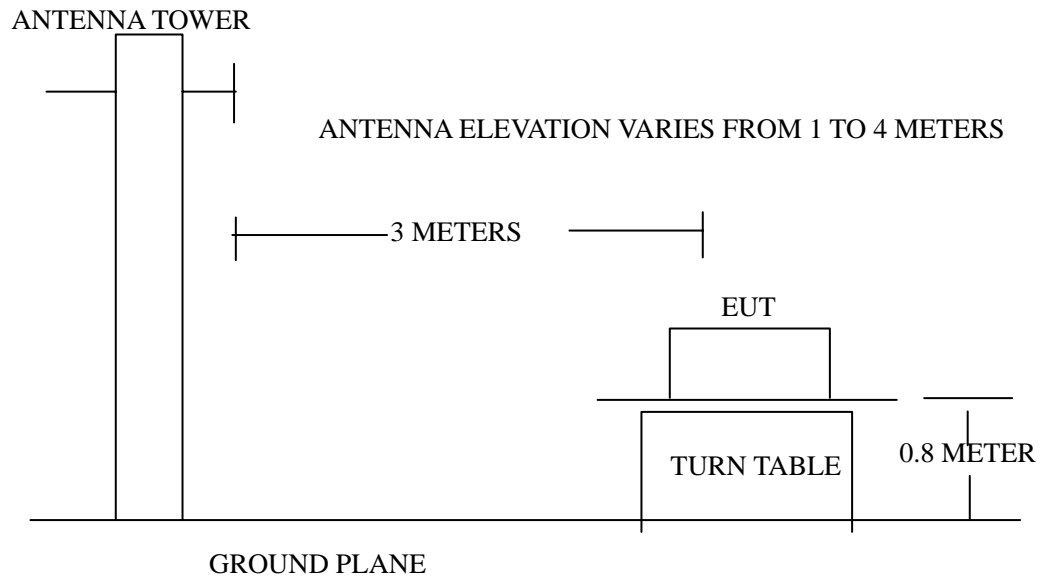

### 6.2. Test Standard

EN 55022:2010

### 6.3. Radiated Emission Limit

All emanations from a Class B computing devices or system, including any network of conductors and apparatus connected thereto, shall not exceed the level of field strengths specified below:

FREQUENCY (MHz)	DISTANCE (Meters)	FIELD STRENGTHS LIMITS (dB $\mu$ V/m)
30 ~ 230	3	40
230 ~ 1000	3	47

Note:(1) The tighter limit shall apply at the edge between two frequency bands.

(2) Distance refers to the distance in meters between the measuring instruments antenna and the closed point of any part of the EUT.



#### 6.4. EUT Configuration on Test

The EN55022 Class B regulations test method must be used to find the maximum emission during radiated emission test.

#### 6.5. Operating Condition of EUT

- 6.5.1. Setup the EUT as shown on Section 6.1.
- 6.5.2. Turn on the power of all equipments.
- 6.5.3. Let the EUT work in test mode (on) and measure it.

#### 6.6. Test Procedure

The EUT is placed on a turn table which is 0.8 meter above ground. The turn table can rotate 360 degrees to determine the position of the maximum emission level. The EUT is set 3 meters away from the receiving antenna which is mounted on a antenna tower. The antenna can move up and down between 1 to 4 meters to find out the maximum emission level. Broadband antenna (calibrated by dipole antenna) are used as a receiving antenna. Both horizontal and vertical polarization of the antenna are set on test. The bandwidth setting on the test receiver (R&S TEST RECEIVER ESCS20) is 120 KHz. The EUT is tested in Semi-Anechoic Chamber. and all the scanning waveform is put in **Appendix I.**

#### 6.7. Test Results

**PASS.**



## 7. HARMONIC CURRENT EMISSION TEST

### 7.1. Block Diagram of Test Setup

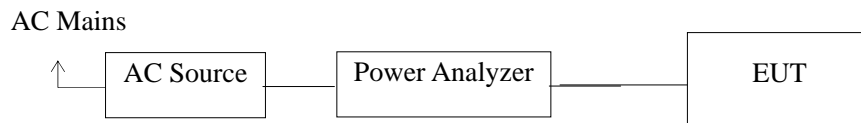

### 7.2. Test Standard and Limit

#### 7.2.1. Test Standard

EN 61000-3-2:2006+A1:2009+A2:2009

#### 7.2.2. Limits

Table 12 Harmonic Current Test Limit (Class A)

Harmonic order (n)	Maximum permissible harmonic current (A)
Odd harmonics	
3	2.30
5	1.14
7	0.77
9	0.40
11	0.33
13	0.21
$15 \leq n \leq 39$	$0.15 \times 15/n$
Even harmonics	
2	1.08
4	0.43
6	0.30
$8 \leq n \leq 40$	$0.23 \times 8/n$





### 7.3. Test Procedure

The power cord of the EUT is connected to the output of the test system. Turn on the Power of the EUT and use the test system to test the harmonic current level.

### 7.4. Test Results

N/A



## 8. VOLTAGE FLUCTUATIONS & FLICKER TEST

### 8.1. Block Diagram of Test Setup

Same as Section 7.1..

### 8.2. Test Standard

EN61000-3-3:2008

### 8.3. Operating Condition of EUT

Same as Section 7.3.. The power cord of the EUT is connected to the output of the test system. Turn on the power of the EUT and use the test system to test the harmonic current level.

Flicker Test Limit

Test items	Limits
Pst	1.0
dc	3.3%
dmax	4.0%
dt	Not exceed 3.3% for 500ms

### 8.4. Test Results

N/A



## 9. ELECTROSTATIC DISCHARGE TEST

### 9.1. Block Diagram of ESD Test Setup

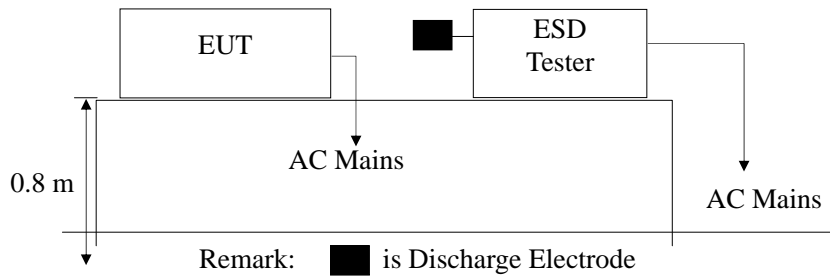

### 9.2. Test Standard

EN 55024:2010(EN61000-4-2:2009)  
Severity Level 3 for Air Discharge at 8KV  
Severity Level 2 for Contact Discharge at 4KV

### 9.3. Severity Levels and Performance Criterion

#### 9.3.1. Severity level

Level	Test Voltage Contact Discharge (KV)	Test Voltage Air Discharge (KV)
1.	2	2
2.	4	4
3.	6	8
4.	8	15
X.	Special	Special

#### 9.3.2. Performance criterion: B

### 9.4. EUT Configuration on Test

The configuration of EUT are listed in Section 3.2.

### 9.5. Operating Condition of EUT

- 9.5.1. Setup the EUT as shown in Section 9.1.
- 9.5.2. Turn on the power of all equipments.
- 9.5.3. Let the EUT work in test mode (on) and test it.



## 9.6. Test Procedure

### 9.6.1. Air Discharge:

This test is done on a non-conductive surfaces. The round discharge tip of the discharge electrode shall be approached as fast as possible to touch the EUT.

After each discharge, the discharge electrode shall be removed from the EUT.

The generator is then re-triggered for a new single discharge and repeated 10 times for each pre-selected test point. This procedure shall be repeated until all the air discharge completed.

### 9.6.2. Contact Discharge:

All the procedure shall be same as Section 9.6.1. except that the tip of the discharge electrode shall touch the EUT before the discharge switch is operated.

### 9.6.3. Indirect discharge for horizontal coupling plane

At least 20 single discharges shall be applied to the horizontal coupling plane, at points on each side of the EUT. The discharge electrode positions vertically at a distance of 0.1m from the EUT and with the discharge electrode touching the coupling plane.

### 9.6.4. Indirect discharge for vertical coupling plane

At least 20 single discharge shall be applied to the center of one vertical edge of the coupling plane. The coupling plane, of dimensions 0.5m X 0.5m, is placed parallel to, and positioned at a distance of 0.1m from the EUT. Discharges shall be applied to the coupling plane, with this plane in sufficient different positions that the four faces of the EUT are completely illuminated.

## 9.7. Test Results

**PASS.**

Please refer to the following page.



## Electrostatic Discharge Test Results

Shenzhen BST Technology Co., Ltd.

Date :01/02/2014

<b>Applicant</b> : SHENZHEN COBAN ELECTRONICS : CO., LIMITED	<b>Test Date</b> : Jan. 02, 2014
<b>EUT</b> : GPS TRACKER	<b>Temperature</b> : 22 °C
<b>M/N</b> : GPS103	<b>Humidity</b> : 50 %
<b>Power Supply</b> : -	<b>Test Mode</b> : on

**Air Discharge:** ±8KV *For each point positive 10 times and negative 10 times discharge.*

**Contact Discharge:** ±4KV

<b>Location</b>	<b>Kind</b> A-Air Discharge C-Contact Discharge	<b>Result</b>
Slots	A	PASS
Metal Parts	C	PASS
HCP	C	PASS
VCP	C	PASS

*Discharge should be considered on Contact and Air and Horizontal Coupling Plane (HCP) and Vertical Coupling Plane (VCP).*

## 10.RF FIELD STRENGTH SUSCEPTIBILITY TEST

### 10.1.R/S Test Setup

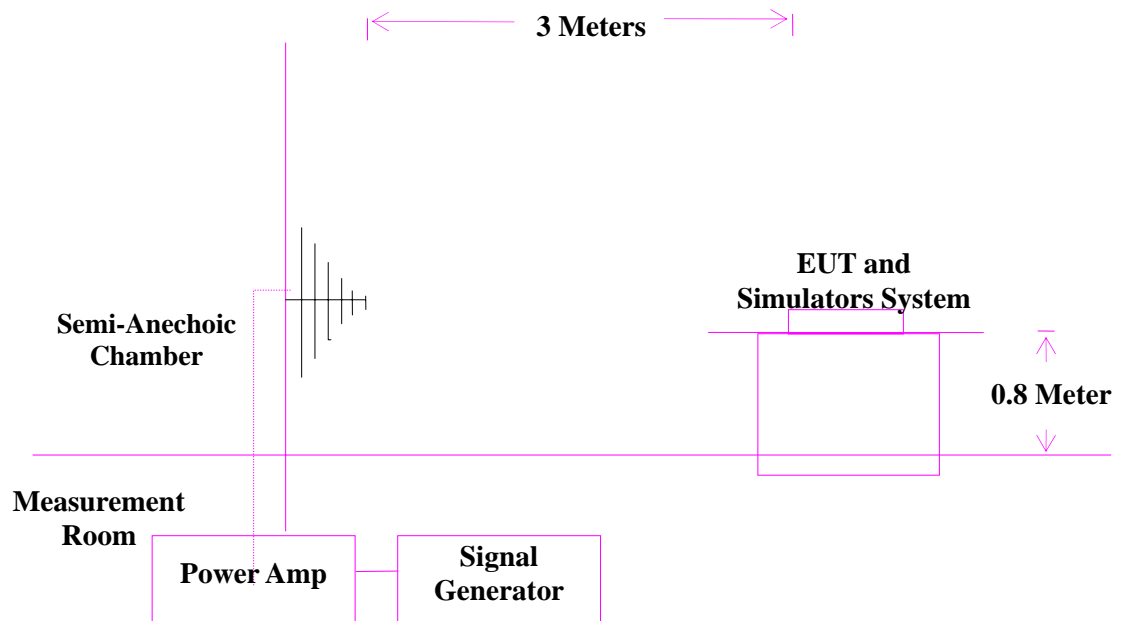

### 10.2.Test Standard

EN 55024:2010 (EN 61000-4-3:2006 + A1:2008 + A2:2010)  
Severity Level 2 at 3V / m

### 10.3.Severity Levels and Performance Criterion

#### 10.3.1.Severity level

Level	Field Strength V/m
1.	1
2.	3
3.	10
X.	Special

#### 10.3.2.Performance criterion : A



#### 10.4.EUT Configuration on Test

The configuration of EUT are listed in Section 3.2

#### 10.5.Operating Condition of EUT

Setup the EUT as shown in Section 10.1.. The operating condition of EUT are listed in section 3.3.

#### 10.6.Test Procedure

The EUT and its simulators are placed on a turn table which is 1 meter above the ground. The EUT is set 3 meters away from the transmitting antenna which is mounted on an antenna tower. Both horizontal and vertical polarization of the antenna are set on test. Each of the four sides of EUT must be faced this transmitting antenna and measured individually.

In order to judge the EUT performance, a CCD camera is used to monitor the EUT.

All the scanning conditions are as follows :

Condition of Test	Remarks
1. Fielded Strength	3 V/m (Severity Level 2)
2. Radiated Signal	Modulated
3. Scanning Frequency	80 - 1000 MHz, 1.4GHz-2.7GHz
4. Sweeping time of radiated	0.0015 decade/s
5. Dwell Time	1 Sec.

#### 10.7.Test Results

**PASS.**

Please refer to the following page.



## RF Field Strength Susceptibility Test Results

Shenzhen BST Technology Co., Ltd.

Date :01/02/2014

<i>Applicant</i> : SHENZHEN COBAN ELECTRONICS  <i>CO., LIMITED</i>	<i>Test Date</i> : Jan. 02, 2014
<i>EUT</i> : GPS TRACKER	<i>Temperature</i> : 22 °C
<i>M/N</i> : GPS103	<i>Humidity</i> : 50 %
<i>Power Supply</i> : -	<i>Test Mode</i> : on
<i>Frequency Range</i> : 80 MHz to 1000 MHz, 1.4GHz-2.7GHz	
<i>Modulation:</i> <input checked="" type="checkbox"/> AM <input type="checkbox"/> Pulse <input type="checkbox"/> Tone 1 KHz 80%	
<i>Criterion</i> : A	
	<i>Frequency Rang</i> : <div style="text-align: center;">80-1000MHZ, 1.4GHz-2.7GHz</div>
<i>Steps</i>	1%
	Horizontal
<i>Front</i>	Pass
<i>Right</i>	Pass
<i>Rear</i>	Pass
<i>Left</i>	Pass





## 11.ELECTRICAL FAST TRANSIENT/BURST TEST

### 11.1.EFT Test Setup

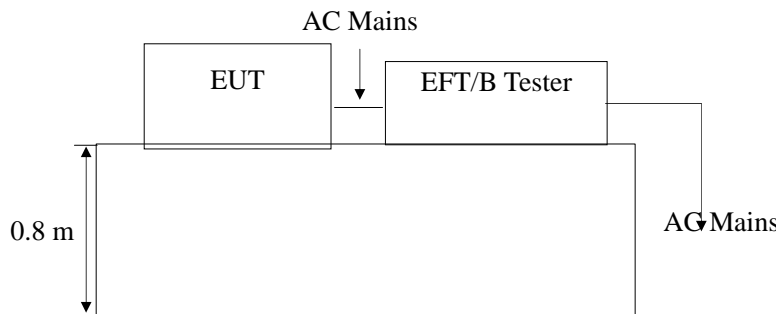

### 11.2.Test Standard

EN 55024:2010 (EN61000-4-4:2004+A1:2010)  
Severity Level 2 at 1KV

### 11.3.Severity Levels and Performance Criterion

#### 11.3.1.Severity level

Open Circuit Output Test Voltage $\pm 10\%$		
Level	On Power Supply Lines	On I/O (Input/Output) Signal data and control lines
1.	0.5 KV	0.25 KV
2.	1 KV	0.5 KV
3.	2 KV	1 KV
4.	4 KV	2 KV
X	Special	Special

#### 11.3.2.Performance criterion : B

### 11.4.EUT Configuration on Test

The configuration of EUT are listed in Section 3.2..

### 11.5.Operating Condition of EUT

Setup the EUT as shown in Section 11.1.. The operating condition of EUT are listed in section 3.3.



## 11.6. Test Procedure

The EUT is put on the table which is 1 meter high above the ground. This reference ground plane shall project beyond the EUT by at least 0.1m on all sides and the minimum distance between the EUT and all other conductive structure, except the ground plane beneath the EUT, shall be more than 0.5m.

### 11.6.1. For input and output AC power ports:

The EUT is connected to the power mains by using a coupling device which couples the EFT interference signal to AC power lines. Both polarities of the test voltage should be applied during compliance test and the duration of the test is 2 mins.

### 11.6.2. For signal lines and control lines ports:

It's unnecessary to test.

### 11.6.3. For DC output line ports:

It's unnecessary to test.

## 11.7. Test Results

N/A



## Electrical Fast Transient/Burst Test Results

Shenzhen BST Technology Co., Ltd.

Date :01/02/2014

<i>Applicant</i>	: SHENZHEN COBAN ELECTRONICS CO., LIMITED	<i>Test Date</i>	: Jan. 02, 2014						
<i>EUT</i>	: GPS TRACKER	<i>Temperature</i>	: 22 °C						
<i>M/N</i>	: GPS103	<i>Humidity</i>	: 50 %						
<i>Power Supply</i>	: -	<i>Test Mode</i>	: -						
<i>Inject Place : AC Mains</i>									
<i>Inject Line</i>	<i>Voltage KV</i>	<i>Inject Time(s)</i>	<i>Inject Method</i>	<i>Results</i>	<i>Inject Line</i>	<i>Voltage KV</i>	<i>Inject Time(s)</i>	<i>Inject Method</i>	<i>Results</i>
<i>L</i>	$\pm 1$	<i>120</i>	<i>Direct</i>	--					
<i>N</i>	$\pm 1$	<i>120</i>	<i>Direct</i>	--					
<i>L N</i>	$\pm 1$	<i>120</i>	<i>Direct</i>	--					



## 12.SURGE TEST

### 12.1.Surge Test Setup

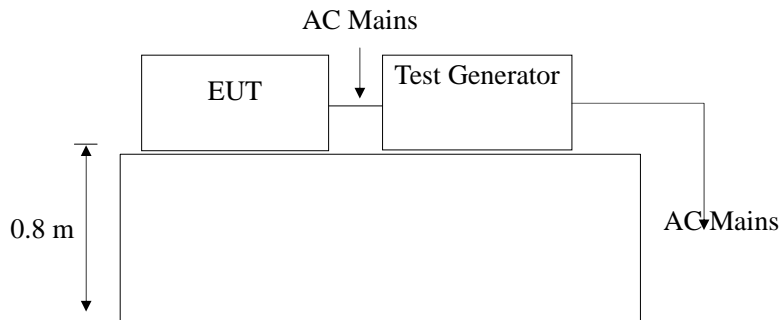

### 12.2.Test Standard

EN 55024:2010 (EN61000-4-5:2006)  
Severity Level 2 for Line to Neutral at 1.0KV

### 12.3.Severity Levels and Performance Criterion

#### 12.3.1.Severity level

Severity Level	Open-Circuit Test Voltage KV
1	0.5
2	1.0
3	2.0
4	4.0
*	Special

Performance criterion : **B**

### 12.4.EUT Configuration on Test

The configuration of EUT are listed in Section 3.2.

### 12.5.Operating Condition of EUT

- 12.5.1.Setup the EUT as shown in Section 12.1..
- 12.5.2.Turn on the power of all equipments.
- 12.5.3.Let the EUT work in test mode (on) and test it.



## 12.6.Test Procedure

- 1) Setup the EUT and test generator as shown on Section 12.1.
- 2) For line to line coupling mode, provide a 1.0KV 1.2/50us voltage surge (at open-circuit condition) and 8/20us current surge to EUT selected points.
- 3) At least 5 positive and 5 negative (polarity) tests with a maximum 1/min repetition rate are conducted during test.
- 4) Different phase angles are done individually.
- 5) Record the EUT operating situation during compliance test and decide the EUT immunity criterion for above each test.

## 12.7.Test Results

N/A



## Surge Immunity Test Results

Shenzhen BST Technology Co., Ltd.

Date :01/02/2014

<i>Applicant</i> : SHENZHEN COBAN ELECTRONICS CO., LIMITED				<i>Test Date</i> : Jan. 02, 2014	
<i>EUT</i> : GPS TRACKER				<i>Temperature</i> : 22 °C	
<i>M/N</i> : GPS103				<i>Humidity</i> : 50 %	
<i>Power Supply</i> : -				<i>Test Mode</i> : -	
Location	Polarity	Phase Angle	No of Pulse	Pulse Voltage (KV)	Result
L-N	+	0	5	1.0	--
	+	90	5	1.0	--
	+	180	5	1.0	--
	+	270	5	1.0	--
	-	0	5	1.0	--
	-	90	5	1.0	--
	-	180	5	1.0	--
	-	270	5	1.0	--



## 13.INJECTED CURRENTS SUSCEPTIBILITY TEST

### 13.1.Block Diagram of Test AC Mains Setup

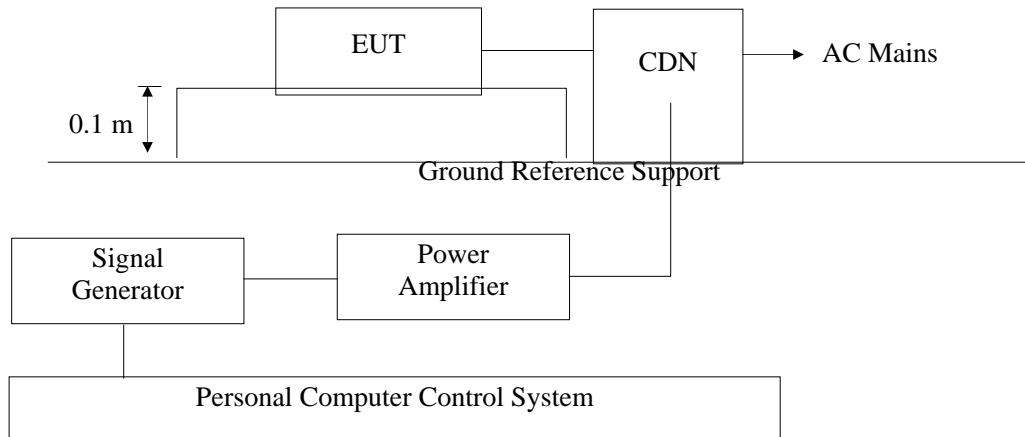

### 13.2.Test Standard

EN 55024:2010 (EN61000-4-6: 2009)  
Severity Level 2 at 3 V (rms), 0.15MHz ~ 80MHz

### 13.3.Severity Levels and Performance Criterion

#### 13.3.1.Severity level

Level	Field Strength V/m
1.	1
2.	3
3.	10
X	Special

#### 13.3.2.Performance criterion: A

### 13.4.EUT Configuration on Test

The configuration of EUT are listed in Section 3.2

### 13.5.Operating Condition of EUT

Setup the EUT as shown in Section 13.1.. The operating condition of EUT are listed in section 3.3



### 13.6.Test Procedure

- 1) Set up the EUT, CDN and test generators as shown on Section 13.1.
- 2) Let the EUT work in test mode and test it.
- 3) The EUT are placed on an insulating support 0.8m high above a ground reference plane. CDN (coupling and decoupling device) is placed on the ground plane about 0.3m from EUT. Cables between CDN and EUT are as short as possible, and their height above the ground reference plane shall be between 30 and 50 mm (where possible).
- 4) The disturbance signal described below is injected to EUT through CDN.
- 5) The EUT operates within its operational mode(s) under intended climatic conditions after power on.
- 6) The frequency range is swept from 150KHz to 80MHz using 3V signal level, and with the disturbance signal 80% amplitude modulated with a 1KHz sine wave.
- 7) The rate of sweep shall not exceed  $1.5 \times 10^{-3}$  decades/s. Where the frequency is swept incrementally, the step size shall not exceed 1% of the start and thereafter 1% of the preceding frequency value.
- 8) Recording the EUT operating situation during compliance testing and decide the EUT immunity criterion.

### 13.7.Test Results

N/A





## Injected Currents Susceptibility Test Results

Shenzhen BST Technology Co., Ltd.

Date :01/02/2014

<i>Applicant</i> : SHENZHEN COBAN ELECTRONICS CO., LIMITED		<i>Test Date</i> : Jan. 02, 2014		
<i>EUT</i> : GPS TRACKER		<i>Temperature</i> : 22 °C		
<i>M/N</i> : GPS103		<i>Humidity</i> : 50 %		
<i>Power Supply</i> : -		<i>Test Mode</i> : -		
<i>Frequency Range (MHz)</i>	<i>Injected Position</i>	<i>Strength</i>	<i>Criterion</i>	<i>Result</i>
0.15 ~ 20	AC Line	3V(rms), Unmodulated	A	--
20 ~ 80	AC Line	3V(rms), Unmodulated	A	--

## 14.MAGNETIC FIELD IMMUNITY TEST

### 14.1.Block Diagram of Test Setup

#### 14.1.1.Block Diagram of the EUT

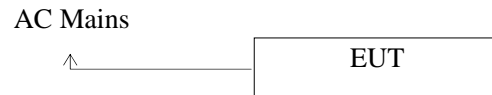

(EUT: GPS TRACKER)

#### 14.1.2.Block Diagram of Test Setup

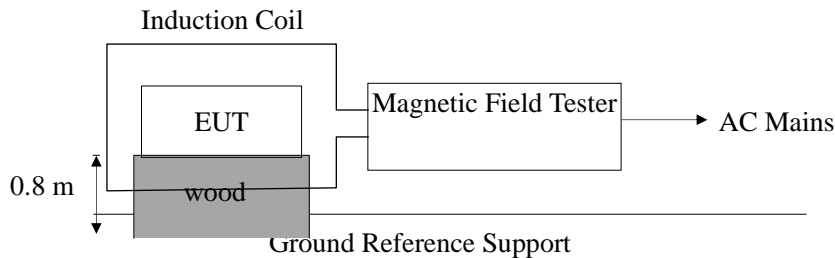

### 14.2.Test Standard

EN 55024:2010 (EN61000-4-8: 2010)

Severity Level 1 at 1A/m

### 14.3.Severity Levels and Performance Criterion

#### 14.3.1.Severity level

Level	Magnetic Field Strength A/m
1.	1
2.	3
3.	10
4.	30
5.	100
X.	Special

#### 14.3.2.Performance criterion : A

### 14.4.EUT Configuration on Test

The configuration of EUT are listed in Section 3.2.



## 14.5.Operating Condition of EUT

- 14.5.1.Setup the EUT as shown in Section 14.1
- 14.5.2.Turn on the power of all equipments.
- 14.5.3.Let the EUT work in test mode (ON) and test it.

## 14.6.Test Procedure

The EUT shall be subjected to the test magnetic field by using the induction coil of standard dimensions (1m\*1m) and shown in Section 14.1. The induction coil shall then be rotated by 90° in order to expose the EUT to the test field with different orientations.

## 14.7.Test Results

**PASS.**

Please refer to the following page.



# Magnetic Field Immunity Test Results

Shenzhen BST Technology Co.,Ltd.

Date : 01/02/2014

Applicant : SHENZHEN COBAN ELECTRONICS CO., LIMITED EUT : GPS TRACKER _____ M/N : GPS103 _____ Power Supply : - _____		Test Date : Jan. 02, 2014 _____ Temperature : 22 °C _____ Humidity : 60 % _____		
Test Mode: <u>ON</u>				
Test Level	Testing Duration	Coil Orientation	Criterion	Result
1A/M	5 mins	Horizontal	A	PASS
1A/M	5 mins	Vertical	A	PASS
Remark:		Test Equipment : Magnetic Field Tester MAG100.1		



## 15. VOLTAGE DIPS AND INTERRUPTIONS TEST

### 15.1. Voltage Dips and Interruptions Test Setup

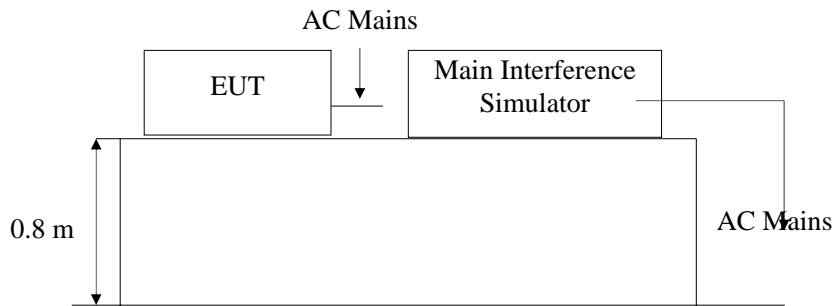

Remark: Combination wave generator and decoupling network are included in test generator.

### 15.2. Test Standard

EN 55024:2010 (EN61000-4-11:2004)

### 15.3. Severity Levels and Performance Criterion

#### 15.3.1. Severity level

Test Level %U <sub>T</sub>	Voltage dip and short interruptions %U <sub>T</sub>	Duration (in period)
0	100	250p
40	60	5p
70	30	0.5p

#### 15.3.2. Performance criterion : C & B

### 15.4. EUT Configuration on Test

The configuration of EUT are listed in Section 3.2.

### 15.5. Operating Condition of EUT

15.5.1. Setup the EUT as shown in Section 15.1.

15.5.2. Turn on the power of all equipments.

15.5.3. Let the EUT work in test mode (SPEAKERS Playing) and test it.



### 15.6.Test Procedure

- 1) Set up the EUT and test generator as shown on Section 15.1.
- 2) The interruptions is introduced at selected phase angles with specified duration.
- 3) Record any degradation of performance.

### 15.7.Test Result

N/A



## Voltage Dips And Interruptions Test Results

Shenzhen BST Technology Co., Ltd

Date :01/02/2014

<i>Applicant</i>	: SHENZHEN COBAN ELECTRONICS CO., LIMITED	<i>Test Date</i>	:	Jan. 02, 2014	
<i>EUT</i>	: GPS TRACKER	<i>Temperature</i>	:	22 °C	
<i>M/N</i>	: GPS103	<i>Humidity</i>	:	50 %	
<i>Power Supply</i>	: -	<i>Test Mode</i>	:	-	
<i>Test Level</i> % $U_T$	<i>Voltage Dips &amp; Short Interruptions</i> % $U_T$	<i>Duration (in period)</i>	<i>Phase Angle</i>	<i>Criterion</i>	<i>Result</i>
0	100	250P	$0^\circ \sim 360^\circ$	C	--
40	60	5P	$0^\circ \sim 360^\circ$	C	--
70	30	0.5P	$0^\circ \sim 360^\circ$	B	--



## APPENDIX I



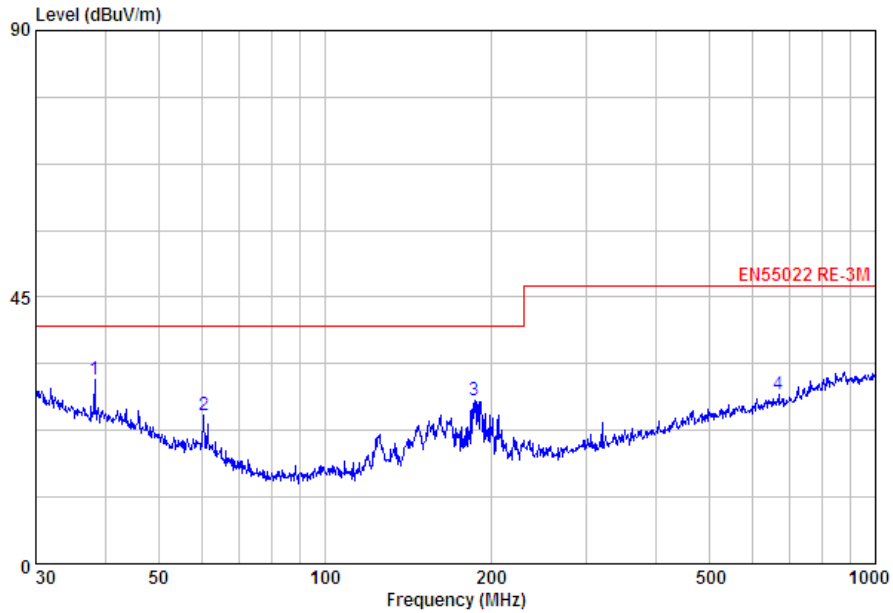

Condition : EN55022 RE-3M 3m HORIZONTAL  
 : RBW:120.000KHz VBW:300.000KHz SWT:Auto

	Freq	Level	Limit	Over	Remark	Pol/Phase
	MHz	dBuV/m	dBuV/m	dB		
1 max	38.35	31.17	40.00	-8.83	Peak	HORIZONTAL
2	60.49	24.98	40.00	-15.02	Peak	HORIZONTAL
3	187.10	27.54	40.00	-12.46	Peak	HORIZONTAL
4	668.14	28.64	47.00	-18.36	Peak	HORIZONTAL

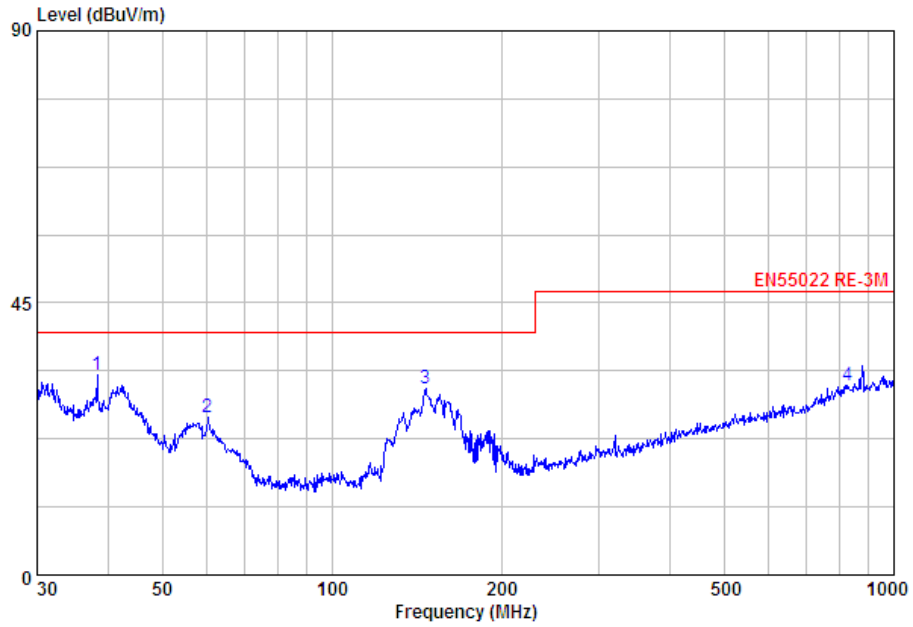

Condition : EN55022 RE-3M 3m VERTICAL  
 : RBW:120.000KHz VBW:300.000KHz SWT:Auto

	Freq	Level	Limit	Over	Remark	Pol/Phase
	MHz	dBuV/m	dBuV/m	dB		
1 max	38.35	33.04	40.00	-6.96	Peak	VERTICAL
2	60.26	26.06	40.00	-13.94	Peak	VERTICAL
3	146.89	30.75	40.00	-9.25	Peak	VERTICAL
4	827.49	31.37	47.00	-15.63	Peak	VERTICAL



## **APPENDIX II**



**Photo 1 General Appearance of the EUT**



**Photo 2 General Appearance of the EUT**



**Photo 3 General Appearance of the EUT**



**Photo 4 General Appearance of the EUT**





**Photo 5 Test scene**

